

See discussions, stats, and author profiles for this publication at: <https://www.researchgate.net/publication/349078067>

# Robust Fuzzy Path Tracking Control of a Platooning Vehicles

Article in Algerian Journal of Signals and Systems · December 2017

DOI: 10.51485/ajss.v2i4.48

---

CITATIONS

0

READS

40

2 authors, including:



Zennir Youcef

Université 20 août 1955-Skikda

113 PUBLICATIONS 406 CITATIONS

SEE PROFILE

People's Democratic Republic of Algeria  
Ministry of Higher Education and Scientific research  
M'hamed Bougara University, Boumerdes  
Institute of Electrical and Electronic Engineering,  
**Laboratory of Signals and Systems (LSS)**

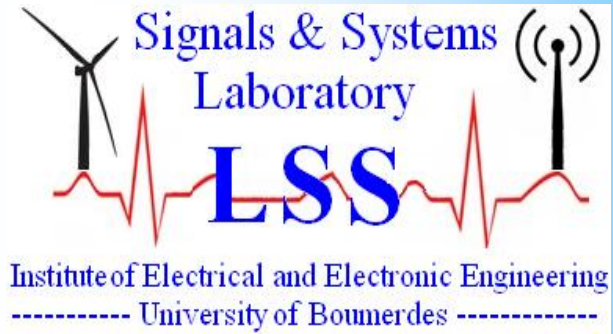

# ALGERIAN JOURNAL OF SIGNALS AND SYSTEMS

ISSN : 2543-3792

**Title: Robust Fuzzy Path Tracking Control of a Platooning Vehicles**

**Authors: Sami ALLOU<sup>(1)</sup>, Youcef ZENNIR<sup>(2)</sup>**

**Affiliations: Automatic laboratory of Skikda, University 20 août 1955 Skikda, Skikda, Algeria**

**Page range: 228- 239**

## IMPORTANT NOTICE

This article is a publication of the Algerian journal of Signals and Systems and is protected by the copyright agreement signed by the authors prior to its publication. This copy is sent to the author for non-commercial research and education use, including for instruction at the author's institution, sharing with colleagues and providing to institution administration. Other uses, namely reproduction and distribution, selling copies, or posting to personal, institutional or third party websites are not allowed.

**Volume : 2 Issue : 4 (December 2017)**

**A special issue of the International Conference on Advanced Engineering in Petrochemical Industry (ICAEPI'17)**

**November 28-30, 2017, Skikda, Algeria**

Laboratory of Signals and Systems

Address : IGEE (Ex-INELEC), Boumerdes University, Avenue de l'indépendance, 35000, Boumerdes, Algeria

Phone/Fax : 024 79 57 66

Email : lss@univ-boumerdes.dz ; ajsyssig@gmail.com

©LSS/2017

# Robust Fuzzy Path Tracking Control of a Platooning Vehicles

Sami ALLOU<sup>(1)</sup>, Youcef ZENNIR<sup>(2)\*</sup>

Automatic laboratory of Skikda, University 20 août 1955 Skikda, Skikda, Algeria  
Email: s.allou@univ-skikda.dz, \*y.zennir@univ-skikda.dz

**Abstract:** The paper present our control approach based in fuzzy controller for platooning vehicles. this approach based to control lateral and longitudinal movement of vehicles in different navigation trajectory. kinematic model of vehicles are described follows by describe of controller design. The communication is provided between vehicles with exchange information, speed and orientation angle with a fixed safety distance between vehicles. 3D simulation developed with matlab, Simulink and v-rep software were carried . Different reference trajectory are used to compared and approve our approach. The simulation results illustrate the efficiency of our control design and open the perspectives for future work.

**Keywords:** Vehicle modeling, Fuzzy logic control approach, platooning vehicles, 3D simulation.

## 1. INTRODUCTION

Transport management and road safety are becoming more important and topical with the exponential growth in the number of vehicles and infrastructure (roads and their condition) which is not keeping pace with this number of vehicles. The saturation of the road network in highways and city centers has become a big problem, hence the need to develop an intelligent network based on autonomous vehicles to optimize the transport system control . these autonomous vehicles have the ability to move alone or together (3-4 vehicles) depending on the mission. the goal of a collective move with a man-driven of one vehicle is to reduce the cost and risk of the mission with intelligent movement in risk areas (presence of obstacles, difficult trajectory, congestion, etc.) (figure 1). Many research in the literature has been done to develop different new intelligent control architecture to control platoons [1], [2], [3][13-15]. The complexity of the transport system control depends in different parameters but the high important parameter is the stability of the travel direction of the platoon, where the communication and cooperation between vehicles requires techniques such as a cooperative adaptive cruise control (ACCS) [4].

In this work we started by the control of a two vehicles, we used a controller based on fuzzy logic to control the vehicles because gives more flexibility, a lot of possibilities between true and false which offer better tracking.

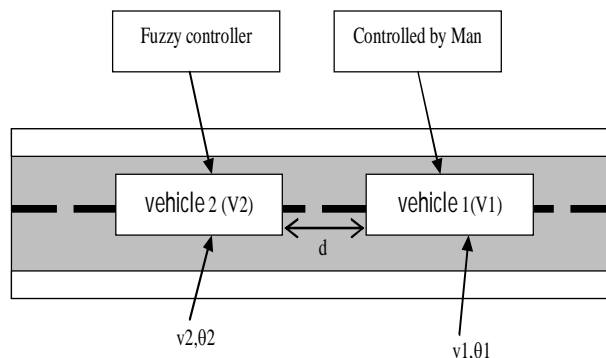

Fig. 1 Architecture of Platooning system

2. AUTOMOUS VEHICLES MODLING

Different model of autonomous electrical vehicles existing in the literature [1], [2]. this model more and less complex depend of the situation and the elements composed the vehicle. The model is more represent the vehicle when its take into account all the forces applied on the system. in this case the control results obtained are high efficient. The first dynamic modeling of the autonomous electrical vehicle that we used are develop by [4] but he doesn't take on consideration all the forces, this model improved by adding some forces to consideration, we used the dynamic model improved proposed in [5] (figure 2). Our work is based on the control study of two autonomous electric vehicles, that used four wheels driven by DC motor, the braking is done by electromagnetic brakes when the absence of current it also has dual front steering system and back. the mathematic model is illustrated by the following equations :

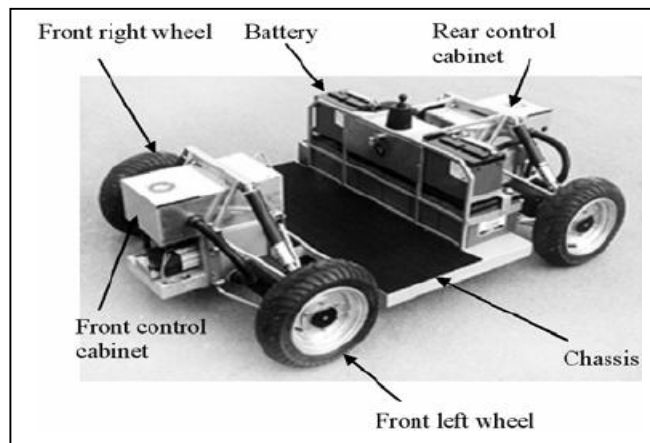

Fig. 2 Electric vehicle (RobuCar) and kinematic model [6]

TABLE 1 USED PARAMETERS IN THE MODELING

$\Psi$	Vehicle yaw angle
$v_G$	The velocity vector at the CG
$v_x, v_y$	The longitudinal and the lateral velocity
$\delta_f, \delta_r$	Steering angle of wheel

The kinematic model of robucar [6] is given by:

$$\dot{x} = v_{moy} \cdot \sin(\Psi + 2\delta_r) \tag{1}$$

$$\dot{y} = v_{moy} \cdot \cos(\Psi + 2\delta_r) \tag{2}$$

$$\dot{\Psi} = v_{moy} \cdot \sin(2\delta_f) / L \cdot \cos(2\delta_f) \tag{3}$$

With :  $\Psi$ : Vehicle angle;  $\delta_f, \delta_r$ : Steering angle;  $v_{moy}$  : average speed. The given kinematic model with double steering system and takes into account three degrees of freedom, both longitudinal and lateral translation with a rotation around lace. In this work we used single steering modes of RobuCar The kinematic model become :

$$\dot{x} = v_1 \cdot \cos(\Psi) \tag{4}$$

$$\dot{y} = v_1 \cdot \sin(\Psi) \tag{5}$$

$$\dot{\theta} = v_2 \quad (6)$$

Where:  $v_1$ : translation speed;  $v_2$ : rotation speed.

**Controller**

To keep the mobile robot on our desired trajectory it is necessary to design a regulator which will allow tracking of arbitrary trajectories  $(x_r(t), y_r(t))$ . The design of controller which we used is based on fuzzy logic it receives the values of distance and the robot location relative to the path as shown in Fig 2, at the output of the controller, then we get the two parameters, the linear speed and the steering angle that will be needed so that the robot always stays on the desired trajectory.

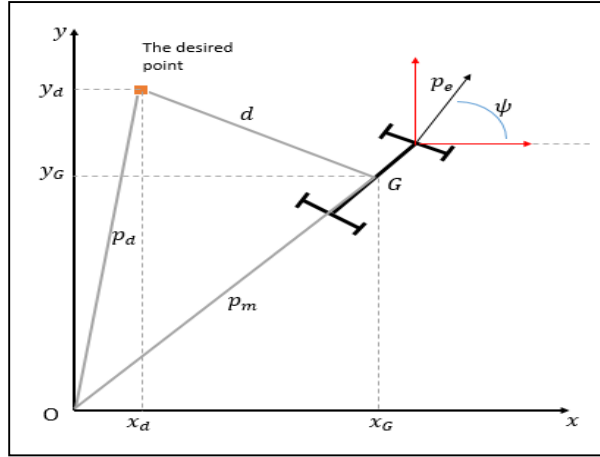

Fig. 3 Technical diagram of the technique

The vectors  $\vec{r}_m, \vec{r}_r, \vec{r}_d$  et  $d$ , are: the position, the desired position, the angle of the orientation and the distance between the current state and the desired position. These vectors are given as follows:

$$\vec{p}_m = x\vec{i} + y\vec{j} \quad (7)$$

$$\vec{p}_d = x_d(t)\vec{i} + y_d(t)\vec{j} \quad (8)$$

$$\vec{p}_e = \cos(\Psi)\vec{i} + \sin(\Psi)\vec{j} \quad (9)$$

$$d = \vec{p}_d - \vec{p}_m = (x_d - x_G)\vec{i} + (y_d - y_G)\vec{j} \quad (10)$$

with :  $x_m, y_m, \theta$  are position and steering angle of the robot.

The norm vector represents the distance between the vehicle and the desired position and the  $Vec_{prod}$  vector represent the orientation of the vehicle.

$$norm = \sqrt{(x_d - x_G)^2 + (y_d - y_G)^2} \quad (11)$$

$$Vec_{prod} = \frac{\vec{p}_e \times \vec{d}}{\|\vec{d}\|} \quad (12)$$

According to Equation (9) and (10)

$$\vec{p}_e \times \vec{d} = (y_d - y_G) \cdot \cos(\theta) - (x_d - x_G) \cdot \sin(\theta) \quad (13)$$

This model is used for the two vehicles. we described the architecture of fuzzy controller in the following section.

### 3. FUZZY CONTROLLER

More and more new strategies of intelligent control are based on fuzzy logic and the application touches all different fields such as robotics (robot manipulator, mobile robot, Unmanned Aerial Vehicle (UAV,..), the enslavement of industrial systems. Fuzzy logic control is based on variables and fuzzy (linguistic) variables that have an integer tick between two "true" values and the "false" value. The values of these variables are words such as: very big, big, medium, small, very small, close, very close, far, very far, high, low, very high, very low ... etc.

The choice of the fuzzy controller type depends in the foreground of the nature of the process to be controlled and in the background the quality of control requested.

In the literature the fuzzy controllers differs either in relation to the number of inputs and outputs, the shape of the control rules or the type of inference engine and the defuzzification method.

It is up to the user to choose the correct architecture of the controller that will be optimal to properly control the process with the requirements of the specifications [6]. These different fuzzy controllers have the same basic structure which is constituted as follows [6-12]:

- Input fuzzification (conversion binary to fuzzy); Fuzzy rule base; Inference engine.
- Output defuzzification (conversion fuzzy to binary conversion)

The design of our fuzzy controller used to control lateral and longitudinal position of vehicles is shown in the following figure:

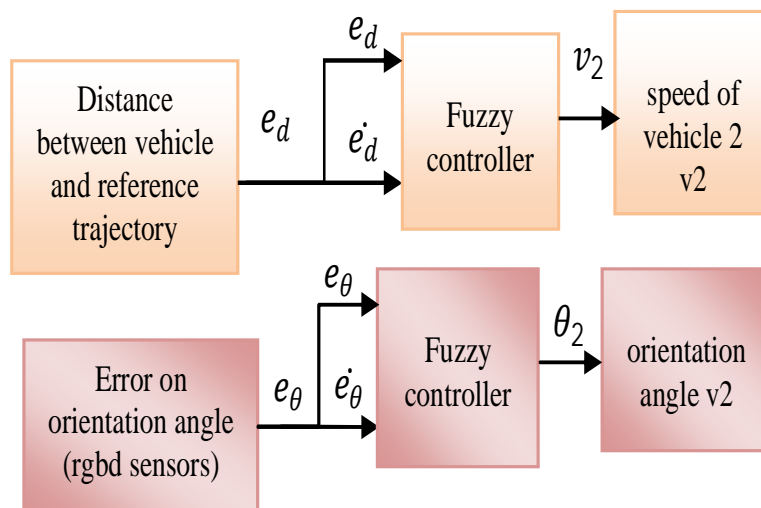

Fig. 4 Fuzzy logic control structure.

and the architecture of controller in SIMULINK is illustrated in the following figure :

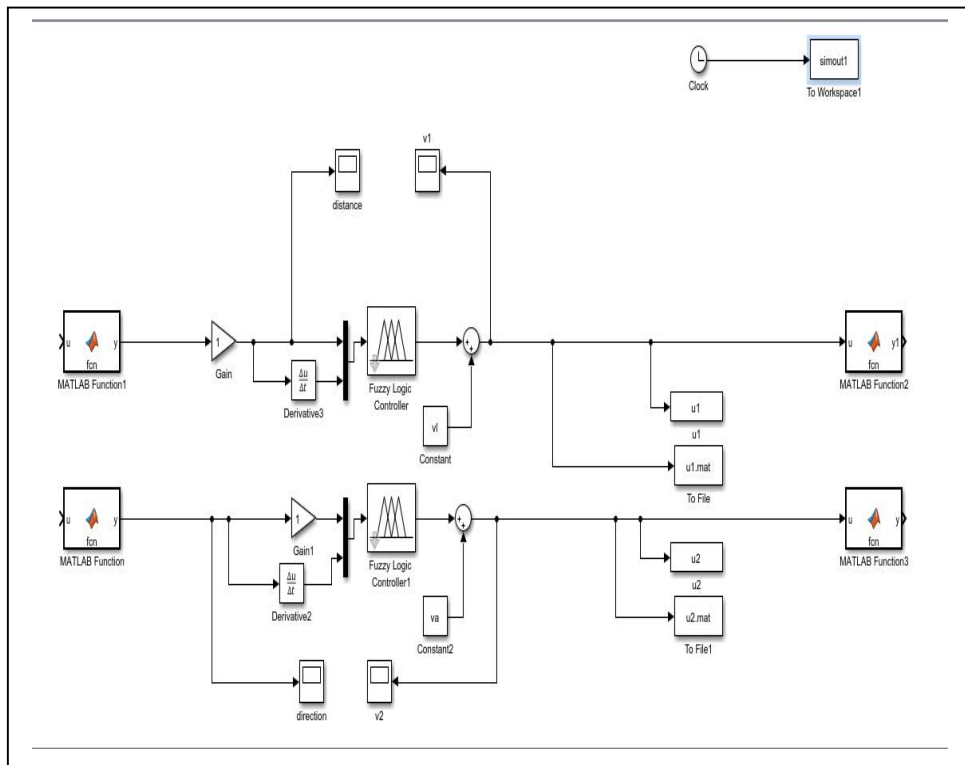

Fig. 5 Control block diagram.

The membership functions are expressed in the following figures.

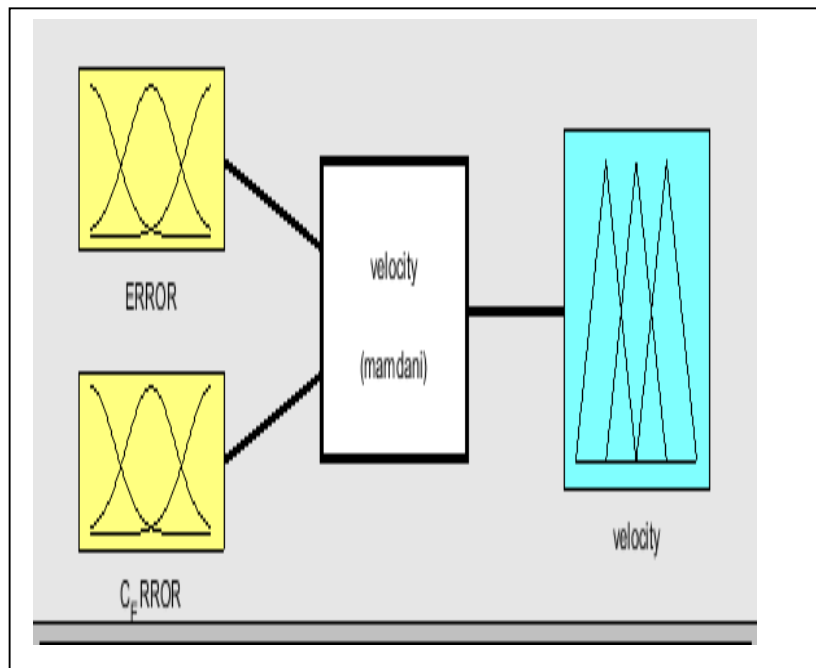

Fig. 6 Input and output membership.

The meaning of the labels designating the names of the linguistic values are:

N: Negative; Z: zero ; P: Positive ; Pm: Positive medium;

PL: Positive large.

**Rule Base:** The rule base is the heart of a fuzzy controller, since the control strategy used to control the closed-loop system is stored as a collection of control rules (Mondani model).

**Inference Engine:** The basic operation of the interference engine is that it “infers,” i.e., it deduces (from evidence or data) a logical conclusion. The inference engine is a program that uses the rule base and the input data of the controller to draw the conclusion. The conclusion of the inference engine is the fuzzy output of the controller, which subsequently becomes the input to the defuzzification interface.

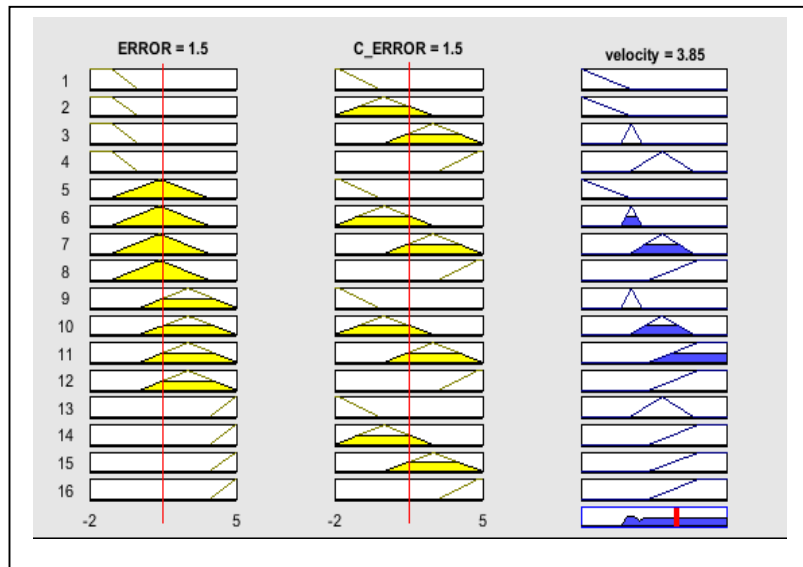

Fig. 7 Rule of vehicle

**Defuzzification interface:** Finally, we make the last operation where the fuzzy conclusion of the inference engine is defuzzified (the conclusion is converted into a crisp control signal). This signal represent the output of fuzzy controller, which is, represent control signal to the process [6].

The 3D simulation has been developed in v-rep software with two vehicles:

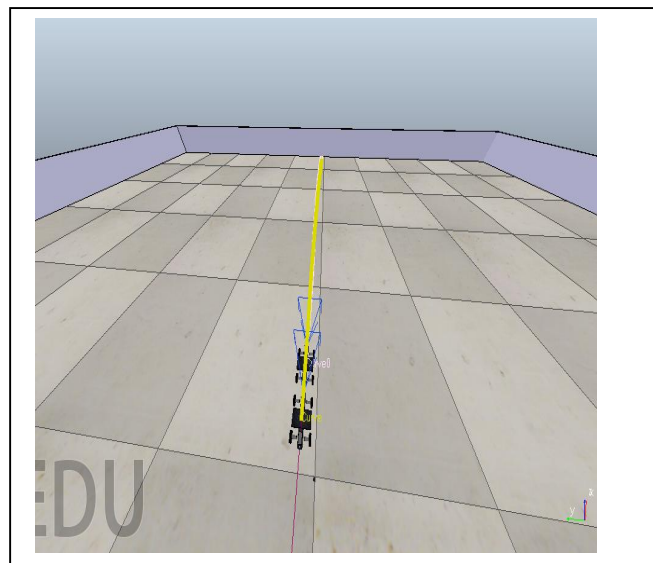

Fig. 8 3D simulation in v-rep with two vehicles



#### 4. SIMULATION

We have simulated our architecture control approach in continues time. The simulation aim is to approve the controller's efficiency on two types of trajectory and curved trajectory like a turn. the obtained results are illustrated in the following figures:

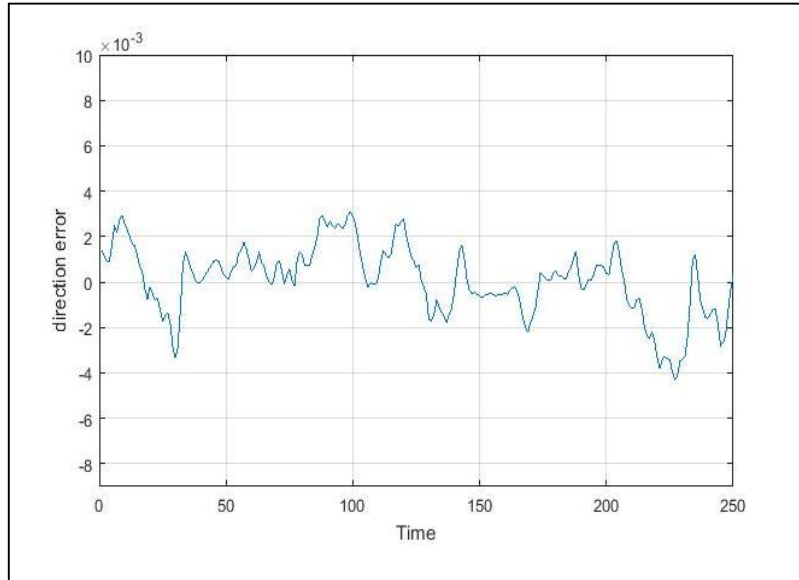

Fig. 9 Curve of direction error.

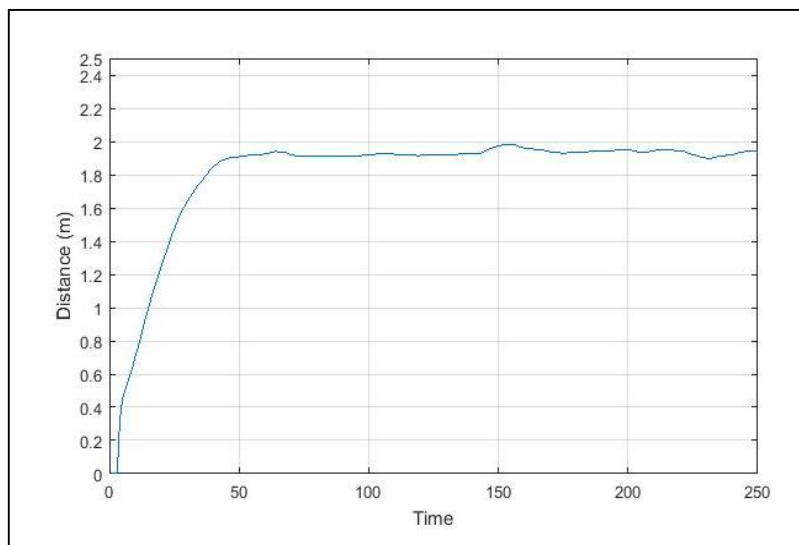

Fig. 10 Curve of saefty distance

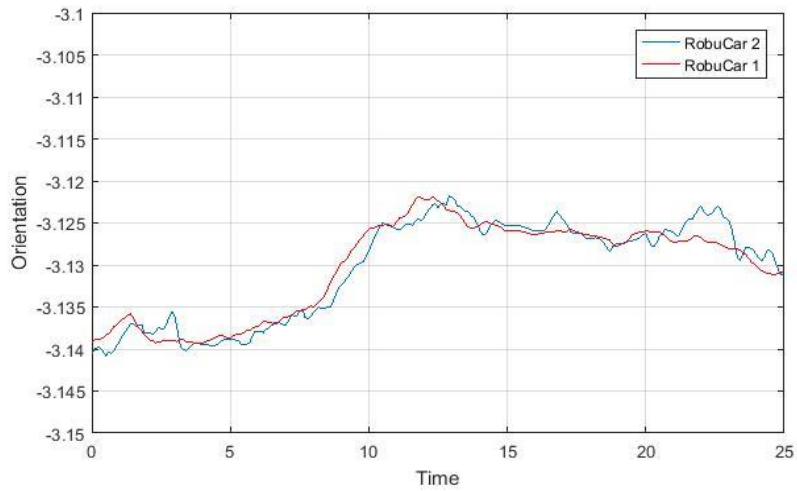

Fig. 11 Curve of orientation angle

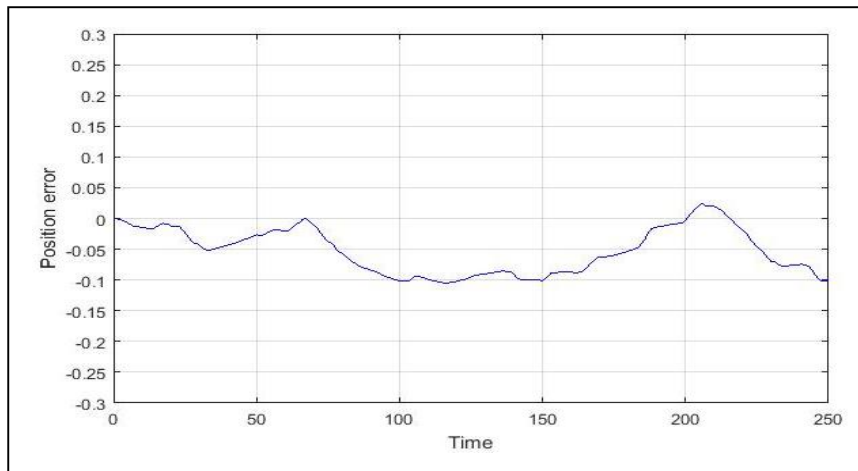

Fig. 12 Curve of Position error

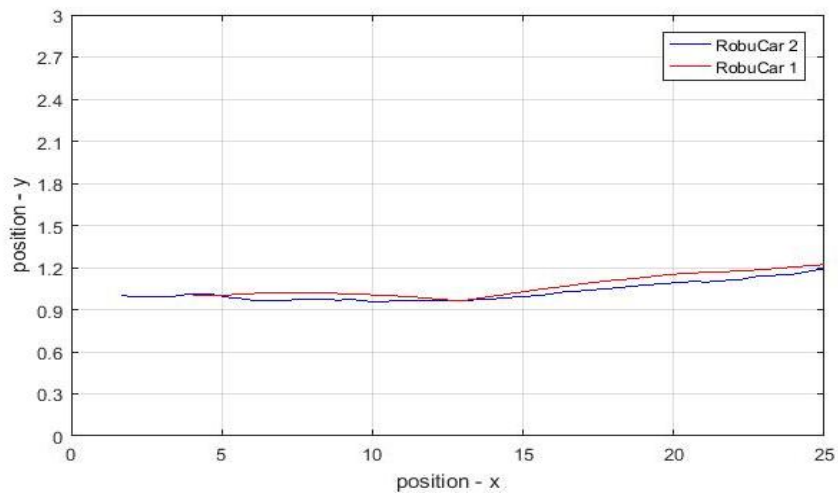

Fig. 13 Curve of two vehicles

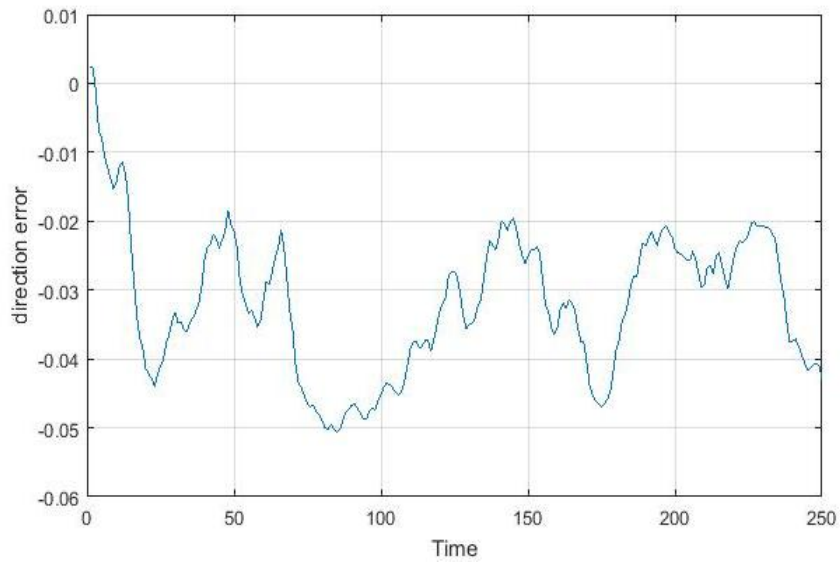

Fig. 14 Curve of direction error

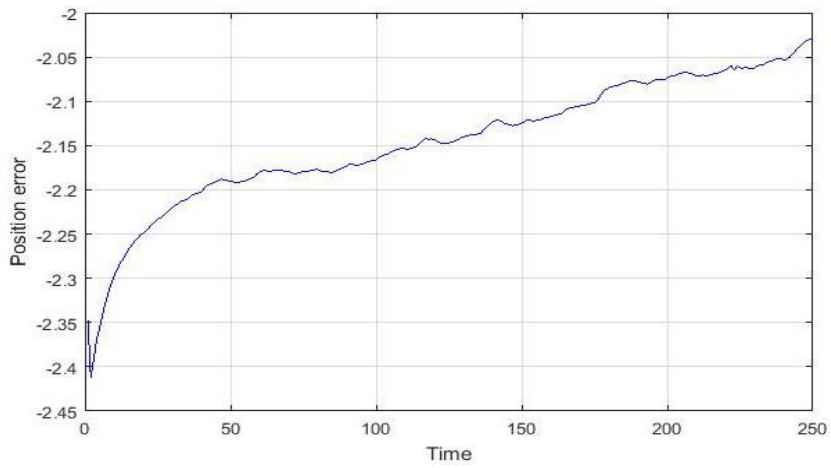

Fig. 15 Curve of saefy distance

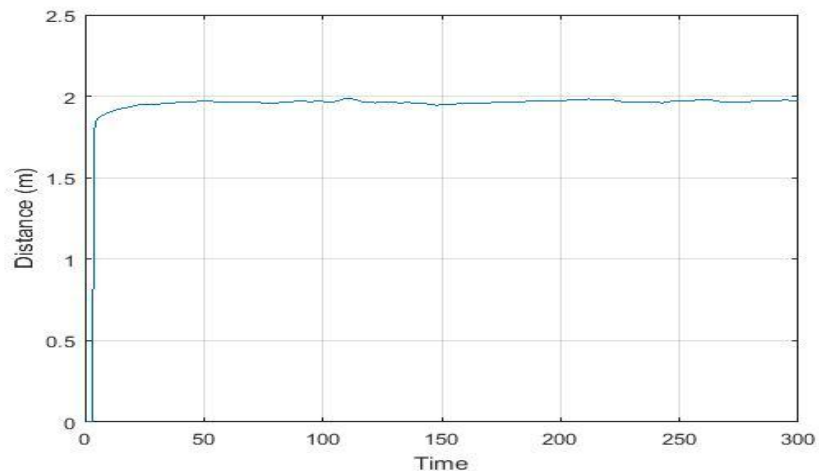

Fig. 16 Curve of orientation angle

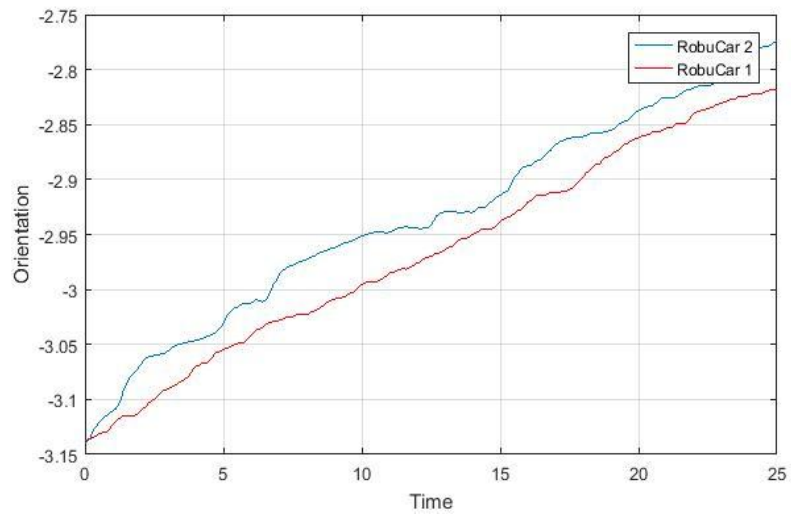

Fig. 17 Curve of position error

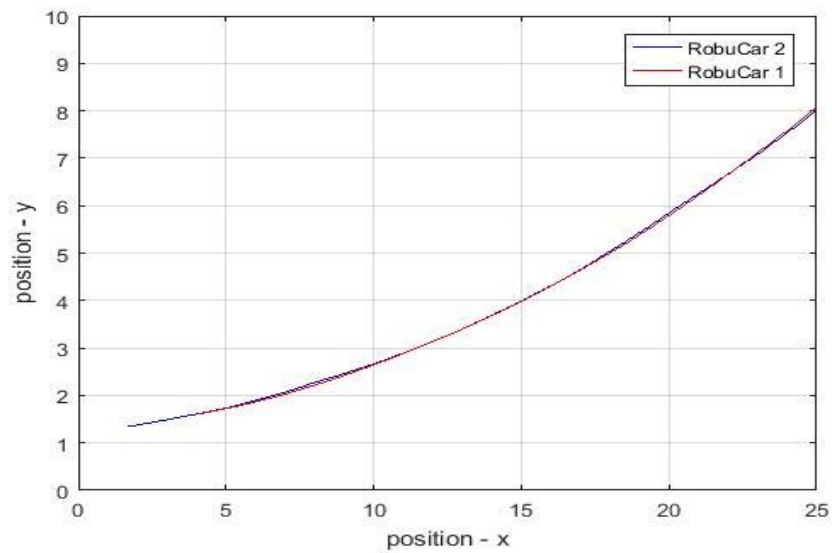

Fig. 18 Trajectory of two vehicles

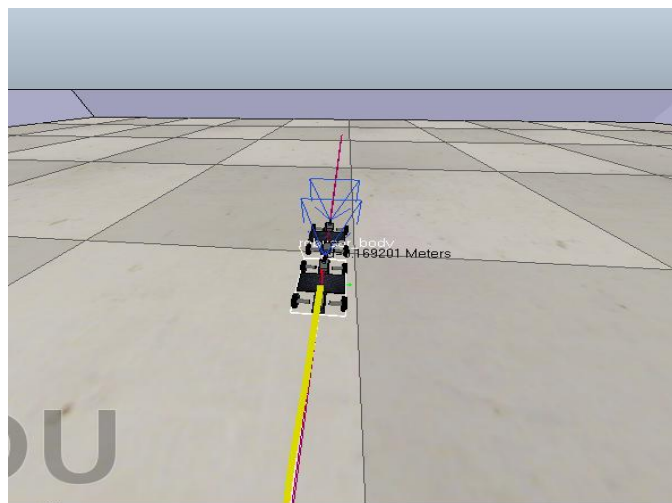

Fig. 19 3D simulation in v-rep with straight trajectory

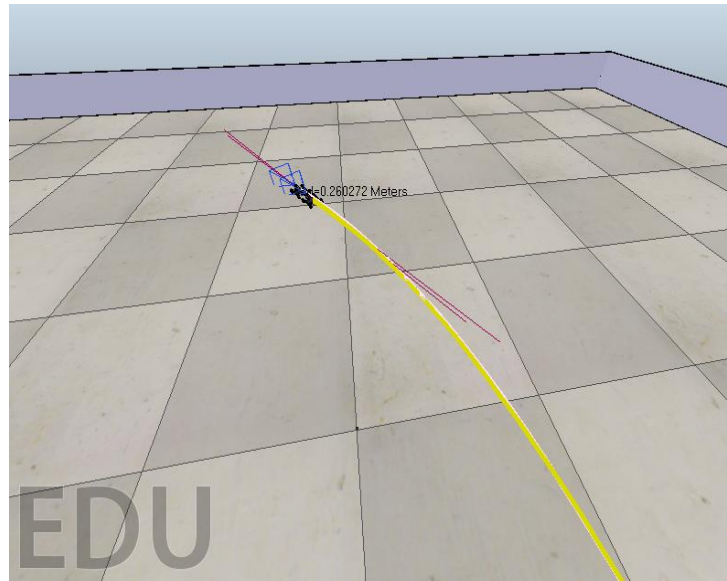

Fig. 20 3D simulation in v-rep with curved trajectory

The results illustrated in figure fig.9-fig.13 shows that the control is very efficiency in a straight trajectory with a very small tracking error and a well respected safety distance.

The results illustrated in figure fig.14-fig.19 shows that the control is less efficiency in a curved trajectory compared to the tracking error and also the orientation angle but the safety distance is well respected. The figure fig.20 and fig.21 illustrated 3D simulation for two trajectories with two vehicles.

## 5. CONCLUSION

In this paper we have proposed path tracking controller for platooning autonomous vehicles with four wheels. The controller chose is based on the fuzzy logic approach; it's able to offer more tracking flexibility and stability. Different simulation has been realized in different trajectory with very interesting results in lateral and longitudinal control of vehicles. The same observations are noticed in the 3D simulation. We conclude that our approach of control must be more optimized where the platooning vehicles travel in curved trajectory. In the future works we plan, to use optimization algorithm like PSO or Genetic algorithm to optimize the parameters of controller.

## REFERENCES

- [1] C. García, T. Strang, A. Lehner, "A Broadcast Vehicle to Vehicle Communication System in Railway Environments", ISVCS 2008 July 22 - 24, 2008, Dublin, Ireland, pp.6.
- [2] L. Bingyi , J. Dongyao, L. Kejie, N. Dong, W. Jianping, and W. Libing, "A Joint Control-Communication Design for Reliable Vehicle Platooning in Hybrid Traffic". IEEE Transactions on Vehicular Technology, 66 (10). pp. 9394-9409.
- [3] P. Fernandes "Platooning of Autonomous Vehicles with Intervehicle Communications in SUMO Traffic Simulator". 13th IEEE International Conference on Intelligent Transportation Systems, Portugal, September, 19-22, 2010, pp.1313-1318.
- [4] Y. Cao and S. liu, "Visual Servo Control for wheeled robot platooning based on homography". 6th Data Driven Control and Learning System, 2017, pp. 628 - 632.
- [5] C. Campolo, A. Mlinaro, G. Araniti and A. O.Berthet, "Better Platooning Control Toward Autonomous Driving: An LTE Device to- Device Communication Thate Meets Ultralow Latency Requirements", IEEEvehicular Technology Magazine. Vol 12, Issue 1 March 2017, pp.30-38.
- [6] J. Ploeg, N. Vande WOuw and H. Nijmeijer, "Lp String Stability of Cascaded systems/ Application to vehicle Platooning", IEEE Trans. On Control Syst. Technologe, vol 22, No 2, March 2014, pp.786-793.
- [7] P-E. Dumont, "Tolérance active aux fautes des systèmes d'instrumentation", Thèse doctorat, université Lille 1, 2006, p.163.
- [8] K. Bouibed, "contribution à la gestion de défaillances d'un train de véhicules électriques légers autonomes ", Thèse doctorat, université Lille 1, 2010,p.181.
- [9] K. Messaoudène and O. Azouaoui, "Personalized Dynamic Model for a Car-like Vehicle "Robucar" Used in Localization", IEEE International Conference on Systems, Man, and Cybernetic,2015,pp.2533-2538.

- [10] I. Baturone, F. J. Moreno-Velo, S. Sánchez-Solano, and A. Ollero, "Automatic Design of Fuzzy Controllers for Car-Like Autonomous Robots". *Ieee Transactions on fuzzy systems*, vol.12, n°.4, 2004.
- [11] R. Pepy, A. Lambert and H. Mounier. Path Planning using a Dynamic Vehicle Model, 2nd Information and Communication Technologies, 2006. ICTTA '06, pp.781-786.
- [12] I. Arad, S. Arogeti, R. Ronen. Coordinated path following control for a group of car-like vehicles with an application to intelligent transportation system.13th International Conference on Control Automation Robotics & Vision (ICARCV), 2014 ,pp.59-64.
- [13] M. Sisto and D. Gu, "A fuzzy leader-follower approach to formation control of multiple mobile robots," in 2006 IEEE/RSJ International Conference on Intelligent Robots and Systems, 2006, pp. 2515–2520.
- [14] F. Vanni, "Coordinated motion control of multiple autonomous underwater vehicles," Ph.D. dissertation, MSc thesis. Instituto Superior Técnico-Dept. of Electrical Engineering. Lisbon, Portugal, 2007.
- [15] F. Arrichiello, "Coordination control of multiple mobile robots," Ph.D.dissertation, Dissertation at Università Degli Studi Di Cassino, Dipartimento Di Automazione, Elettromagnetismo, Ingegneria Dell informazione E Matematica Industriale, 2006.