

See discussions, stats, and author profiles for this publication at: <https://www.researchgate.net/publication/324000026>

Robust H^∞ Controller of a Nonlinear Unstable System: Robotics Wrist

Article in *International Journal of Mathematical Models and Methods in Applied Sciences* · December 2017

CITATION

1

READS

105

2 authors:



Zennir Youcef

Université 20 août 1955-Skikda

113 PUBLICATIONS 407 CITATIONS

SEE PROFILE



Mohand Said Larabi

Université 20 août 1955-Skikda

6 PUBLICATIONS 5 CITATIONS

SEE PROFILE

Robust H_∞ Controller of a nonlinear unstable system: Robotics wrist

Youcef ZENNIR

Automatic laboratory of Skikda
Université 20 août 1955 Skikda
Skikda, Algeria
y.zennir@univ-skikda.dz

Mohand Said LARABI

Automatic laboratory of Skikda
Université 20 août 1955 Skikda
Skikda, Algeria
ms.larabi@univ-skikda.dz

Abstract— The paper presents a new multi-controllers approach with H_∞ control applied to control a manipulator robot wrist (Staubli RX-90). A brief description of process and linear mathematical modeling of the process. Principle of multi-controllers approach of control is briefly presented. Our new proposals concerning the type of the controllers used in the multi-controller approach of control and which are one controller based on H_∞ control for nonlinear system and linear local models around each operating points. The principal of H_∞ control has been described and finally the simulation results obtained approve the efficiency of our design control followed by a conclusion and some perspectives for future work.

Keywords— Modeling, Manipulateur robot, H_∞ Control, multi-model approach.

I. INTRODUCTION

Precise, optimal and robust control of manipulators arm in the face of uncertainties and variations in their environments is a prerequisite to feasible application of robot manipulators to complex handling and assembly problems in industry and space [1]. An important step toward achieving such control can be taken by providing manipulator hands with sensors that provide information about the progress of interactions with the environment. But more important is the lack of adequate controller architectures and computing techniques needed to take advantage of such sensory information, where it available.

Different architectures and techniques are used to control the manipulator arms [1], like multi-controller approach developed by Narandra & balakrishnan [2] base in RST controller or fuzzy controller with frank switching system and fuzzy switching system [3].

Other approach of control used same approach with PID controller, Fractional order PID controller and PSO-PID controller [4-6]. Other approach in litterateur, used nonlinear controller [5], adaptive controller [6].

The mechanical design of the manipulator arm has an influence on the choice of control type. The physical process (robot arm) behavior has generally many non-linearity [5] that are not taken into account in the modeling process. In the each operating point (equilibrium point) of the physical process we can develop a local linear model. In this work we used multi-model approach [2].

Then the objective of this approach [1] is to control the process in operational space using the local information [2][3].

We have proposed same modification in this approach and the diagram block of the multi-controllers approach modified is represented as follows:

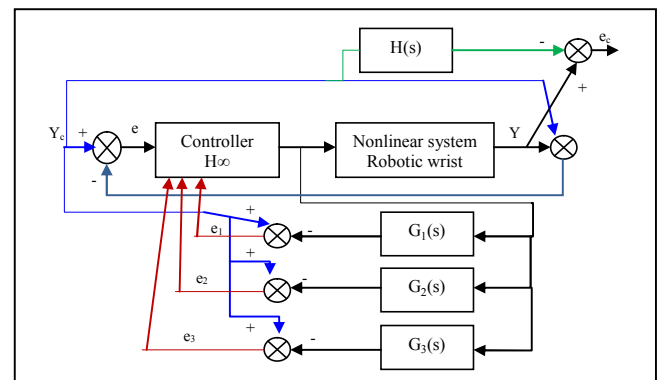

Fig.1. Structure of multi-model approach of control.

In our work, we have chosen the use one optimal H_∞ controller works in all in operational space with three linear local models around each operating point.

II. PROCESSUS MODELING

The manipulator Stäubli Robot Rx-90 has coupling between axis 5 and 6. The actuators are brushless motors and the engine control uses the rotor position to magnetic flux rotate to achieve desired torque value and generally this motor as a DC motor behave[5]. Our process corresponds to a robot wrist (axis 6) can be represented by the following figure:

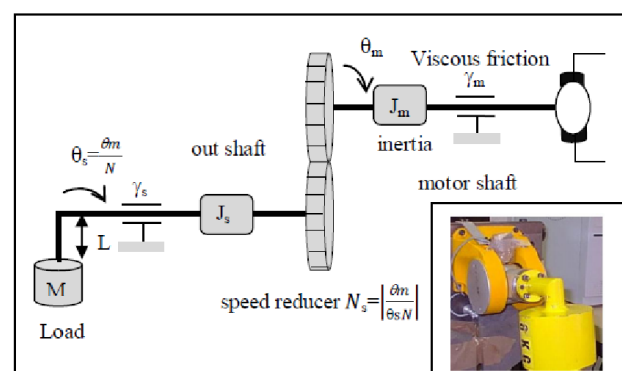

Fig.2. Process (Robot wrist) model.

Mathematic Process dynamic model is given by the following equations:

$$\Gamma_m - \Gamma_s = \left(J_m + \frac{J_s + M.L^2}{N^2} \right) \cdot \ddot{\theta}_m + \left(\gamma_m + \frac{\gamma_s}{N^2} \right) \cdot \dot{\theta}_m \quad (1)$$

With : $J_T = \left(J_m + \frac{J_s + M.L^2}{N^2} \right)$ and $\gamma_T = \left(\gamma_m + \frac{\gamma_s}{N^2} \right)$ (2)

J_m, J_s : Inertia moment applied in the motor shaft and the output shaft (output shaft with mass) respectively.

γ_m, γ_s : Viscous friction applied in the motor shaft and the output shaft respectively.

The motor torque is given by: $\Gamma_m = K_e \cdot u(t)$ (3)

K_e : is the torque constant and $u(t)$ the voltage applied in process. To find the linear structure of local parametric models, we applied the tangent linearization methods and the linear local model is as follows [5]:

$$G(s) = \frac{-K_p}{s^2 + a_{p1} \cdot s + a_{p2}} \quad (4)$$

After identification of the linear system near operating point $\theta_{s0}=0$ [10]. We have used an integrator in the process model (for example (5)) for does no use the equilibrium point (u_0, y_0) in to the control laws. Indeed, he will give the nominal control and he guarantees the statics performances [5]. The corresponding continuous linear model is as follows:

- operating points, $\theta_{s0}=0$:

$$G_1(s) = \frac{-111.5}{s \cdot (s^2 + 11.25 \cdot s + 79.14)} \quad (5)$$

- operating points, $\theta_{s0}=\pi/3$ and $\theta_{s0}=2\pi/3$ respectively:

$$G_2(s) = \frac{-111.5}{s \cdot (s^2 + 11.25 \cdot s + 39.57)} \quad G_3(s) = \frac{-111.5}{s \cdot (s^2 + 11.25 \cdot s - 39.57)} \quad (6)$$

Reference model is :

$$H(p) = \frac{\gamma^3}{(s+\gamma)^3} \quad (7)$$

With: $\gamma=10$;

III. OPTIMAL CONTROL WITH H_∞

Several representations can be used for control problems of closed loop systems, such as H_∞ and H_2 optimization problems. It is therefore practical to have recourse to a general formulation, in order to have a "standard problem" for this type of controls. The configuration of the closed loop system with the various specifications (weighting functions) is shown in Figure (3).

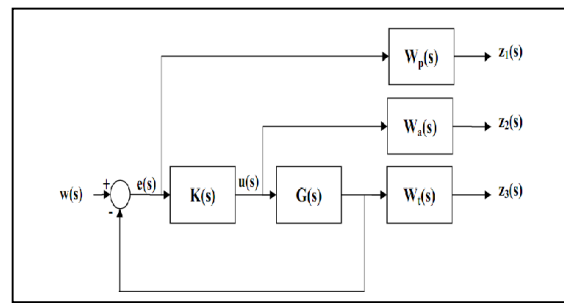

Fig.3. Problem formulation Standard

Where: $W_\lambda(s)$: transfer matrix of the stability specification.

$W_a(s)$: transfer matrix relating to the additive error.

$W_p(s)$: matrix for transferring the performance specification.

Note: In the following, we are only interested in the case where the uncertainties are of unstructured type.

The general configuration of the standard problem [7-17] is presented in Figure (4) (LFT, Linear Fractional Transformations representation [12-14]).

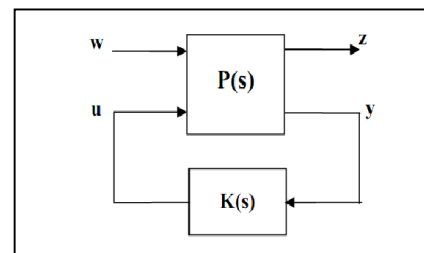

Fig.4. Standard problem (LFT representation)

Where: u : system commands (dimension " m ")

w : perturbed inputs (dimension " l ")

y : measurements on the system (outputs) (dimension " q ")

z : controlled outputs (dimension " p ")

x : state vector (dimension " n ")

The solution of the standard problem (generalized mixed sensitivity problem) is found by finding a control law u - delivered by a controller $K(s)$ - such that: $u = K(s) \cdot y$ minimizing the influence of the perturbation signal w on the output signal z , namely:

$$\left\| \begin{bmatrix} W_p S \\ W_a R \\ W_t T \end{bmatrix} \right\|_\infty < 1 \quad (8)$$

$T(s)$: Complementary Sensitivity defined by

$$T(s) = L(s)(I + L(s))^{-1} \quad (9)$$

L(s): is the Open loop L(s) = G(s) K(s)
 R(s): Transfer to Control defined by

$$R(s) = K(s)(I + L(s))^{-1} \tag{10}$$

S(s): Sensitivity defined by:

$$S(s) = (I + L(s))^{-1} \tag{11}$$

The different matrices are enclosed in a single system, called the augmented plant P(s). It is defined by the following equations of state ([8], [11]):

$$\begin{cases} \dot{x} = Ax + B_1w + B_2u \\ z = C_1x + D_{12}u \\ y = C_2x + D_{21}w \end{cases} \tag{12}$$

The advantage of using these state equations is that we have a complete knowledge of the system and the weighting functions (W_t(s), W_a(s) and W_p(s)). In the form of a LFT representation:

$$P(s) = \begin{bmatrix} A & B_1 & B_2 \\ C_1 & D_{11} & D_{12} \\ C_2 & D_{21} & D_{22} \end{bmatrix} \tag{13}$$

In the form of a transfer matrix:

$$P(s) = \begin{bmatrix} W_p & -W_p G \\ 0 & W_a \\ 0 & W_t G \\ I & -G \end{bmatrix} \tag{14}$$

We associate with the standard problem the following cost function T_{zw}:

$$T_{zw}(s) = P_{11}(s) + P_{12}(s)K(s) + [I - P_{22}(s)K(s)]^{-1}P_{21}(s) \tag{15}$$

With $P(s) = \begin{bmatrix} P_{11}(s) & P_{12}(s) \\ P_{21}(s) & P_{22}(s) \end{bmatrix}$

From where $(s) = T_{zw}(s)w(s)$ (16)

In the following we are interested in the problem H_∞ based on Riccati equations resolution ([15], [16]). The solution of the H_∞ problem is based on the verification of the following hypotheses [11-17]:

(H₁) : The pair (A, B₂) is stabilizable and the pair (A, C₂) is detectable.

(H₂) - D₁₂ and D₂₁ : are of full rank.

$$(H_3) - rank \begin{bmatrix} A - j\omega I & B_2 \\ C_1 & D_{12} \end{bmatrix} = n + m \tag{17}$$

$$(H_4) - rank \begin{bmatrix} A - j\omega I & B_1 \\ C_2 & D_{21} \end{bmatrix} = n + q \tag{18}$$

We will illustrate the steps for obtaining the K(s) controller by solving the problem H_∞. The problem of optimization by H_∞ is to find a controller K(s) stabilizing the process, so as to minimize the transfer between the inputs w and the outputs z, namely:

$$\|T_{zw}(j\omega)\|_{\infty} = \max_{\omega} \bar{\sigma}(T_{zw}(j\omega)) \tag{19}$$

To obtain the structure of the controller K(s), we are interested in the problem H_∞ "suboptimal", where we try to reduce the norm H_∞ below a positive threshold γ. For the standard problem of figure (4) defined by equations (2) to (6) and verifying the hypotheses (H₁) to (H₄), there exists a controller K(s) which ensures internal stability [6] such that:

$$\|T_{zw}(j\omega)\|_{\infty} \leq \gamma \text{ for } \gamma > 0 \tag{20}$$

If and only if ([11-17]):

$$H_{\infty} \in dom (Ric) \text{ and } X_{\infty} = Ric(H_{\infty}) \geq 0 \tag{21}$$

$$J_{\infty} \in dom (Ric) \text{ and } Y_{\infty} = Ric(J_{\infty}) \geq 0 \tag{22}$$

$$\max \lambda(X_{\infty} Y_{\infty}) < \gamma^2 \tag{23}$$

Such that: X_∞ and Y_∞ are the solutions of the Hamiltonians below:

$$H_{\infty} \begin{bmatrix} A & \gamma^{-2}B_1B_1' - B_2B_2' \\ -C_1' C_1 & -A' \end{bmatrix} \tag{24}$$

$$J_{\infty} \begin{bmatrix} A' & \gamma^{-2}C_1' C_1 - C_2' C_2 \\ -B_1B_1' & -A \end{bmatrix} \tag{25}$$

And their corresponding Riccati equations below:

$$A'X + XA + C_1' C_1 + X(\gamma^{-2}B_1B_1' - B_2B_2')X = 0 \tag{26}$$

$$AY + YA' + B_1B_1' + Y(\gamma^{-2}C_1' C_1 - C_2' C_2)Y = 0 \tag{27}$$

In this case, the controller K(s) satisfying the condition: $\|T_{zw}(j\omega)\|_{\infty} \leq \gamma$ is expressed as the following LFT representation: $K(s) = F_l(M_{\infty}, Q)$ with:

$$M_{\infty} = \begin{bmatrix} A_{\infty} & -Z_{\infty}B_1 & Z_{\infty}B_2 \\ F_{\infty} & 0 & I \\ -C_2 & I & 0 \end{bmatrix} \tag{28}$$

With :

$$\begin{cases} A_{\infty} = A + \gamma^{-2}B_1B_1'X_{\infty} + B_2F_{\infty} + Z_{\infty}L_{\infty}C_2 \\ F_{\infty} = -B_2X_{\infty} \\ L_{\infty} = -Y_{\infty}C_2' \\ Z_{\infty} = (I - \gamma^{-2}Y_{\infty}X_{\infty})^{-1} \end{cases} \tag{29}$$

$Q(s)$ is any stable transfer function of norm H_∞ less than γ , namely: $\|Q\|_\infty < \gamma$. A special case is the central controller, it is obtained if: $Q(s) = 0$. The central controller $K(s)$ is then written in this way:

$$K(s) = \begin{bmatrix} A_\infty & -Z_\infty L_\infty \\ F_\infty & 0 \end{bmatrix} \quad (30)$$

$$K(s) = -Z_\infty L_\infty (sI - A_\infty)^{-1} F_\infty \quad (31)$$

The mixed sensitivity problem is a special case of the standard H_∞ problem. It consists in finding a robust controller $K(s)$ capable of maintaining the closed-loop stability and of ensuring the required performances ([13]) such that:

$$\|T_{zw}(j\omega)\|_\infty = \left\| \begin{bmatrix} W_p S \\ W_t T \end{bmatrix} \right\|_\infty < 1 \quad (32)$$

Several necessary criteria must be ensured in closed-loop systems control: attenuation and rejection of disturbances, limitation of the energy delivered to the system, and of course robustness [8]. By including the sensitivity $S(s)$ in the synthesis, this will result in the attenuation of the effect of the perturbations, while the complementary sensitivity $T(s)$ will have the pursuit problem of the output z at the input w [15]. The association of the sensitivity function $S(s)$ will give rise to a controller which ensures closed-loop stability and attenuates the resonance peaks on the maximum singular value of the sensitivity $S(s)$ [17]. In this case, the standard H_∞ problem becomes:

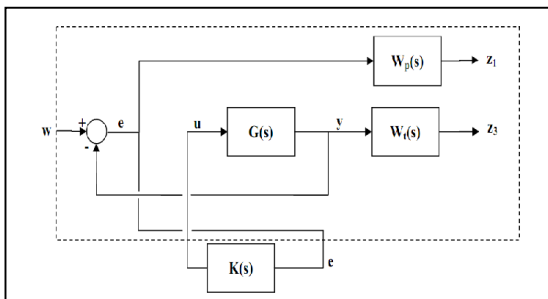

Fig.5. Mixed sensitivity problem in standard form

The solution to the problem of optimization by H_∞ previously stated will be realized by the iteration on the parameter γ and the optimal robust controller $K(s)$ will have to satisfy the condition: $\|T_{zw}(j\omega)\|_\infty \leq \gamma$. Thus, the parameter γ will satisfy the compromise "Stability / Performance".

We presented the problem H_∞ with the steps for the determination of the robust controllers. All these calculation steps can be considered long before obtaining controller structure, because they must be carried out for each value of the parameter γ . It is therefore preferable to use a calculation algorithm, which will make it possible to obtain the robust controller in a faster and more precise manner. A

computational algorithm for the determination of the robust controller is presented by:

1. Choice of specifications W_t, W_p and W_a .
2. Realization of the augmented plant $P(s)$.
3. Take $\gamma = 1$, synthesize controller H_∞ .
4. Calculation of the cost function T_{zw} .
5. If $\|T_{zw}(j\omega)\|_\infty \leq \gamma$ go to 7.
6. Otherwise adjust γ and go to 2.
7. Evaluation of frequency and temporal results.
8. If the results are satisfactory go to 10.
9. Otherwise adjust γ and go to 1.
10. End.

Fig.6. Algorithm of H_∞ controller

The controllers' structure $K(s)$, in addition to having the possibility to refine the results of the synthesis with adjustment parameter γ . The implementation of the controller will be obtained by software of MATLAB via Robust Control.

IV. SIMULATION

The object of this simulation is the illustration of H_∞ controller efficiency and the stability of closed loop control. The simulation is done in continuous time around the following operating points $\theta_{s0}=0\text{rad}$, $\theta_{s0}=\pi/3\text{rad}$ and $\theta_{s0}=2\pi/3\text{rad}$. In our work, we consider the perturbations as inverse output multiplicative uncertainties [17], which are the gap between the linearized models around the three operating points and the nonlinear model. The following Fig. 7 shows the general configuration of a closed loop controller with system "robotic wrist" subject to inverse output multiplicative uncertainties.

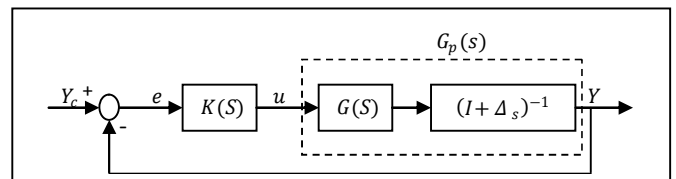

Fig.7. Feedback configuration with inverse output multiplicative uncertainties

Where : $K(s)$ is the controller, $\Delta_s(s)$ are inverse output multiplicative uncertainties of the system that include all the disturbances that act in the robot wrist, $G_p(s)$ is the perturbed system and $G(s)$ is the nominal system. According to Fig. 7, the perturbed system can be deduced by the following relation:

$$G_p(s) = (I + \Delta_s(s))^{-1} G(s) \quad (33)$$

Then, we obtain the inverse multiplicative uncertainties Δ_s by the following formula:

$$\Delta_s(s) = (G(s) - G_p(s)) G_p^{-1}(s) \quad (34)$$

Figure 8 shows the plot of the maximum singular values of the inverse multiplicative uncertainties $\Delta_s(s)$, which are bounded by the maximum singular values of the stability specification W_t , such that:

$$\bar{\sigma}[\Delta_s(j\omega)] \leq \bar{\sigma}[W_t(j\omega)] \quad (35)$$

We note that the uncertainties are stronger at low frequencies without exceeding 100% and decreasing at high

frequencies, which means a high disturbance at low frequencies (the steady state).

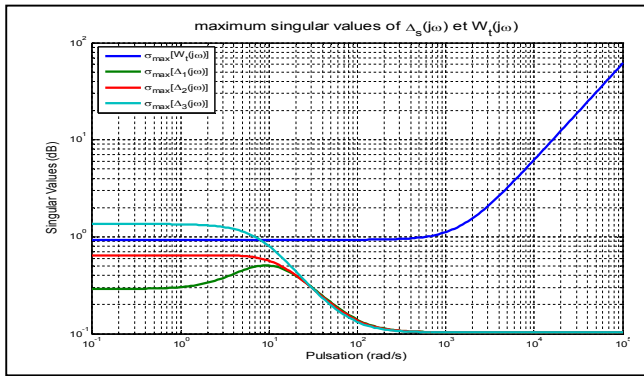

Fig.8. The maximum singular values of the system uncertainties $\Delta_s(j\omega)$ and of the stability specification $W_t(j\omega)$

From Fig. 8 it is possible to determine the transfer function of $W_t(s)$ by identification, one obtains:

$$W_t(s) = 0.93 \begin{pmatrix} 1+6 & 66710 & -5s \\ 1+0.510 & & -6s \end{pmatrix} \quad (36)$$

To guarantee the stability of the system perturbed by the H_∞ controller, the following robust stability condition must first be ensured [16-17] and from the relation (32) we can write:

$$\bar{\sigma}[T(s) \cdot W_t(s)] < 1 \quad (37)$$

Where it comes from: $\bar{\sigma}[T(s)] < \bar{\sigma}[W_t(s)]^{-1}$ (38)

Thus, in order to ensure the performance robustness, i.e. to satisfy the desired performances, a gentle response without overshoot, zero steady-state and an acceptable settling time, for the perturbed system in closed loop, it is necessary to guarantee the following performance robustness condition, [16-17]:

$$\bar{\sigma}[S(s) \cdot W_p(s)] < 1 \text{ or } \bar{\sigma}[S(s)] < \bar{\sigma}[W_p(s)]^{-1} \quad (39)$$

Where: W_p is a weighting function chosen to satisfy the requirements of the previous desired performance specifications, see Fig. 9, there is also a high gain in low frequencies, integrator action, therefore we choose the weighting function of the following form:

$$W_p(s) = 0.6 \begin{pmatrix} 1+116 & 510 & -3s \\ 5.10 & -6+116 & 510 & -3s \end{pmatrix} \quad (40)$$

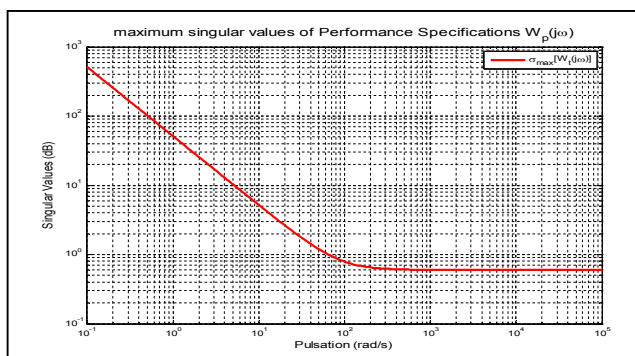

Fig.9. The maximum singular values of the Performance specifications $W_p(j\omega)$

After all, the robustness conditions for robotics wrist are represented in Fig. 10:

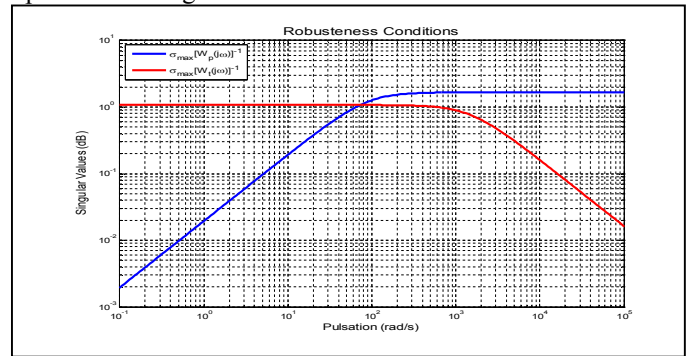

Fig.10. Robustness Conditions

According to Fig. 11, it can be said that the stability and performances robustness conditions are guaranteed (38) and (39) respectively.

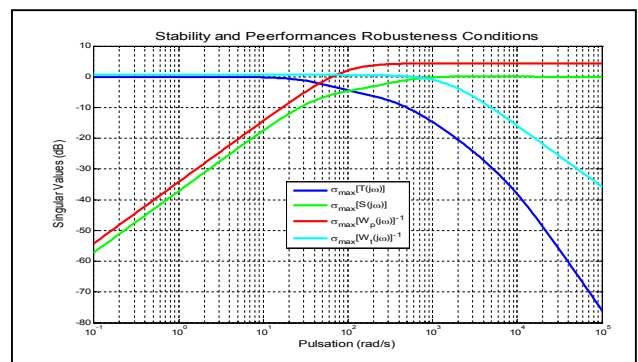

Fig.11. Singular Values of the Stability and Performances Robustness Conditions

In the following, the results are illustrated in the time domain. By applying a sinusoidal signal to the input of the closed-loop control system:

$$y_c = \left(\frac{\pi}{3}\right) \sin(5 \cdot t) \quad (41)$$

Where the sampling period is defined $T = 0,001$ sec .

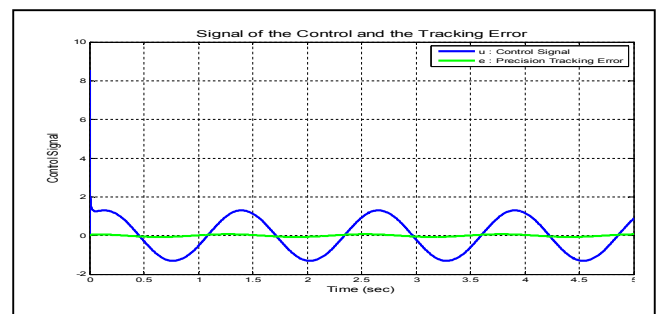

Fig.12. Signal of the Control and Tracking Error

In the figure above, a high precision tracking performance with a minimization of the energy is observed. The following figures illustrate the temporal response of the closed loop controlled system for the nominal and perturbed operating regimes.

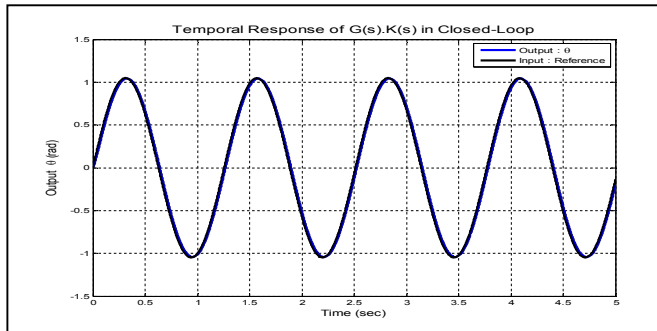

Fig.13. Temporal response of the controlled closed loop nominal system

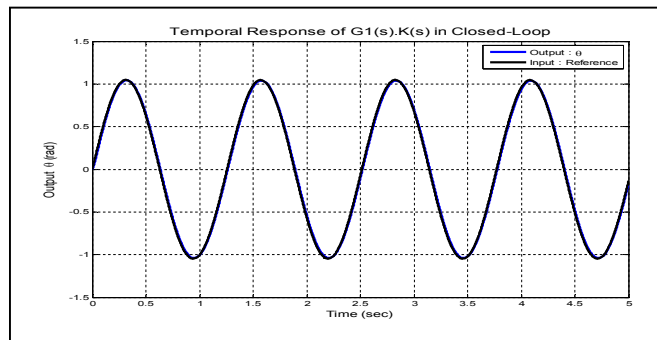

Fig.14. Temporal response of the controlled closed loop Perturbed system with first operating point

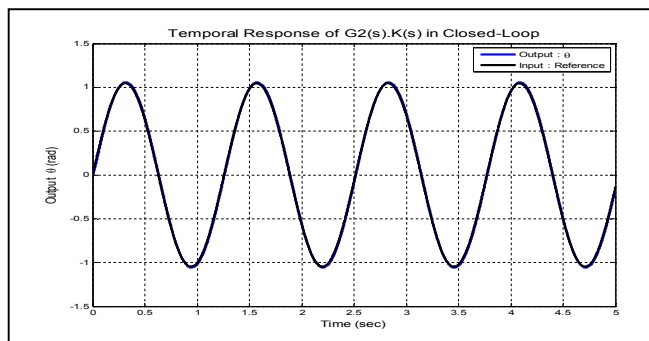

Fig.15. Temporal response of the controlled closed loop Perturbed system with second operating point

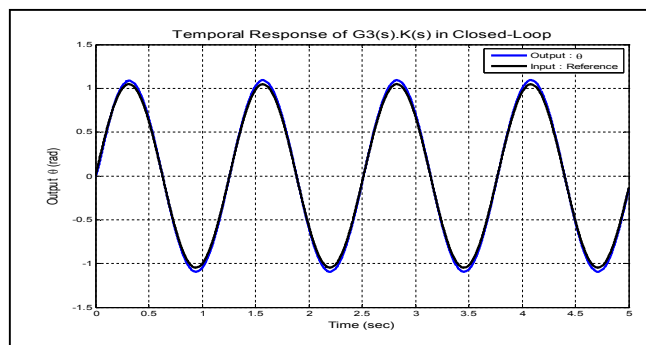

Fig.16. Temporal response of the controlled closed loop Perturbed system with third operating point

We can observe with obtained results illustrated in Fig.13 at Fig-16, the controller H^∞ can be powerfully control nonlinear system and all locals linear models in the same time. We can observed too the high robustness and precision of our controller.

V. CONCLUSION

In this work, we have presented the modeling of nonlinear process (robotics wrist of RX90 Stäubli Robot). After that the local linear model near each considered operating points has been calculated. We have described the H^∞ controller with our new design control of multi-control approach. Simulation we noted that the obtained results approve the high robustness and precision of our controller and design control approach. The results obtained allow concluding that we can control nonlinear system with one robust controller and this controller give good results in local linear model obtained around each operating points. Finally we will study at the future work other robust control approach with optimization with algorithm inspired in biologic like (PSO, GA,..).

REFERENCES

- [1] J.J.E. Slotine, "Applied Nonlinear Control". Prentice-HallInternational, 1991, ISBN: 0-13-040049.
- [2] A. Karimi and I-D. Landau, "Robust Adaptive Control of a Flexible Transmission System Using Multiple Models". Laboratoire d'Automatique de Grenoble (CNRS-INPG-UJF). Design-CSD,1998.
- [3] O. Pagès, P. Mouille and B. Caron, "Two approaches of the multi-model control. Real time Implementation for a wrist of a Robot". Mechatronics 2000, 1st IFAC Conference on mechatronic systems, Darmstadt, Allemagne, Septembre, 2000.
- [4] R. Toscano., D. Martin-Calle and P. Passerieu, "Adaptation paramétrique floue d'une commande au premier ordre en fonction du point d'équilibre courant". Laboratoire d'Automatique E.N.I St ETIENNE LFA'97 -Lyon-décembre, pp.3-10.
- [5] Y.Zennir, P. Mouille, "Multi-controllers approach applied to a wrist of a robot "25 European Modeling and Simulation Symposium (EMSS'2013),p.6.
- [6] Y. Zennir, M-S. Larabi and H. Zemali, Robust PI^2D , H^∞ and Smith Predictor Controller Design for Time Delay Systems In Proceedings of the 14th International Conference on Informatics in Control, Automation and Robotics (ICINCO 2017) - Volume 1, pages 543-550.
- [7] L. Wei-Min and D. John. " H^∞ Control of Nonlinear Systems: A Class of Controllers. Technical memorandum No. CIT-CDS 93-008 May 13,1993, p.43.
- [8] W. Min, Z. Lingbo and L. Guoping. Adaptive Robust H^∞ Control for Nonlinear Systems with Parametric Uncertainties and External Disturbances.
- [9] X. Wang, L. Gao, S. Zhang. Robust H^∞ control of a class of uncertain nonlinear systems. Sinica Automatica, 1999, Vol. 25, No. 2,pp. 221-225.
- [10] .K Nguang. Robust Nonlinear H^∞ -Output Feedback Control. IEEE Transaction on Automatic Control, 1996, Vol.41, No. 7, pp. 1003-1007.
- [11] G. Lu, Y. Zheng. Robust H^∞ control for a class of nonlinear uncertain systems. Sinica Automatica, 1999, Vol.25, No. 3, pp. 388-392
- [12] M. Wu, L. Zhang, W. Gui. Robustness analysis and synthesis for a class of nonlinear systems with additive uncertainties. Control Theory and Application, 2002,Vol. 19, No. 2, pp.203-206
- [13] Y. Fu, Z. Tian, S. Shi. H^∞ robust control of the state delayed uncertain nonlinear systems. Sinica Automatica, 2001, Vol. 27, No. 2, pp.224-228.
- [14] M. Wu, L. Zhang, G. P. Liu. Robust control of a class of nonlinear systems with l^∞ -bounded disturbances. Control Theory and Application, Vol. 19, No. 3: 369-2375, 2002 .
- [15] D. Milich, L. Valavani and M. Athans, "Feedback System Design with an Uncertainty Plant" Laboratory for Information and Decision Systems, M.I.T., LIDS-P-1614, October 1986.
- [16] J.C. Doyle and G. Stein, "Multivariable Feedback Design: Concepts for a Classical Modern Synthesis". IEEE. Trans. Automat. Control, vol.AC-26,1981, N°1,pp.4-16.
- [17] M.G. Savonov and R.Y. Chiang, , "CACSD using the State Space L^∞ Theory-A Desing". Trans.Automat. Control.AC33, 1988,N°5,pp.477-479.